



**MERLIN™**  
LAZER

# INSTRUCTION SHEET

The Merlin Lazer gauge measures glass thickness and air gaps in any combination on clear single or multi-glazed units quickly, easily and from one side only.

## 1 Glass thickness

This scale gives a one-touch measurement for glass thickness.

## 2 Air gap

This scale will measure the air gap in any clear double or triple glazed unit. Used in conjunction with the Glass Thickness scale, it will enable the overall thickness of any double or triple glazed unit to be measured quickly and simply.

## 3 Zero line

This is the point of reference for all measurements.

## 4 Scale slide button

With the help of the raised logo button, the scale can be moved to the left or right to set the zero line to the required position.

## 5 Laser on/off button

Press to activate laser. When the button is released the laser is turned off automatically.

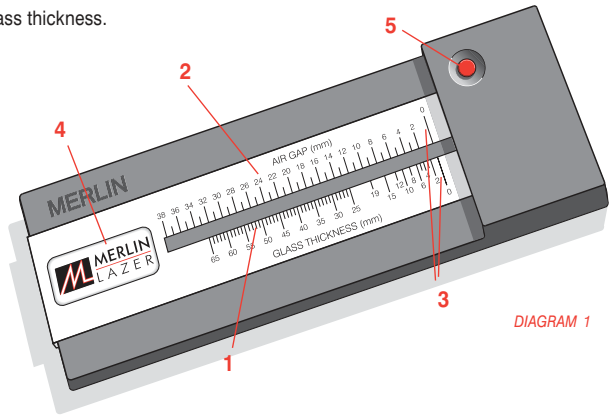

DIAGRAM 1

## How to use the Merlin Lazer

Whatever type of clear glass is being measured, ensure that the Merlin Lazer is placed flat against the glass face at eye level.

When measuring double or triple glazed units, ensure that the right hand, raised edge butts up against the bottom right or top right corner of the unit in order to obtain a true reading for the air gap (Diagram 2) - as air gap thickness may deviate towards the centre of the unit.

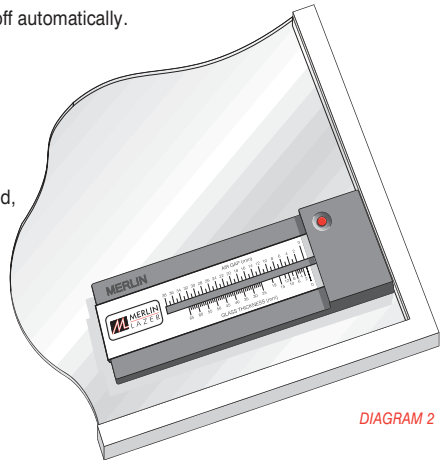

DIAGRAM 2

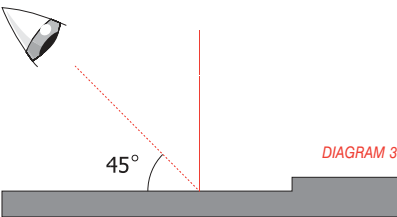

DIAGRAM 3

For the clearest reading of the red laser lines on the calibrated scale, view at an angle of approximately 45 degrees. (Diagram 3).

## Identifying different types of glass

The components of various types of glass will become easily identifiable by the number and brightness of the red laser lines:

<b>Single skin</b>	Two red laser lines are visible.
<b>Double glazed</b>	Four red laser lines are visible.
<b>Double glazed (coated)</b>	Four red laser lines are visible. One of these laser lines will be brighter than the others, indicating the coated surface (eg. K-Glass, Low-E etc).
<b>Triple glazed</b>	Six red laser lines are visible.

## LAMINATED SAFETY GLASS

<b>Two panes with a single interlayer</b>	Three red laser lines are visible. One is fainter than the others indicating the interlayer. With thicker interlayers two faint lines will be visible which indicate the thickness of the interlayer.
<b>Mult-pane laminate (e.g. Security/Pyro glass)</b>	Two bright red laser lines show the overall thickness of the multi-laminated pane. The fainter lines between indicate the individual glass and interlayer thicknesses.

The following examples will show you just how easy the Merlin Lazer gauge is to use. If you require any further information please ring our help line on 01892 654141 between 9.00am and 5.00pm Monday to Friday.

## Measuring single sheet glass

### Example 1

Place Merlin Lazer flat against glass surface. Press the red button and hold it down, viewing the calibrated scale from approx 45 degrees. Two bright red laser lines will be visible. Check that the first laser line (A) is aligned with the zero line on the scale. The second laser line (B) shows the glass thickness to be 10mm (Diagram 4).

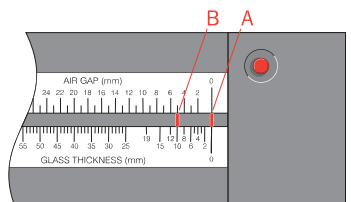

DIAGRAM 4

## Measuring double glazed units

### Example 2, double glazed

Press the red button and hold it down, viewing the calibrated scale from approx 45 degrees. In this example five red laser lines are visible - four are bright, the fifth slightly fainter. Check that the first laser line (A) is aligned with the zero line on the scale. The second laser line (B) shows the thickness of the first pane of glass - this is shown on the Glass Thickness scale as 4mm (Diagram 5).

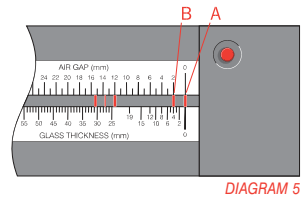

DIAGRAM 5

Slide the scale's zero line to align with laser line (B). Measure the air gap on the Air Gap scale, shown as 10mm by laser line (C) (Diagram 6).

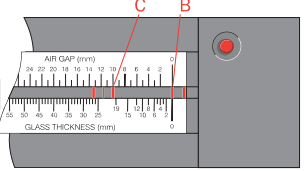

DIAGRAM 6

Slide the scale's zero line to align with laser line (C). Measure the thickness of the second pane of glass on the Glass Thickness scale. This is shown in Diagram 7 to be 6.4mm by the bright laser line (E).

Laser line (D) is slightly fainter than (C) or (E), indicating a laminate.

**This shows the unit to have been made up from 4mm glass; 10mm air gap; 6.4mm laminated glass and having an overall thickness of 20.4mm.**

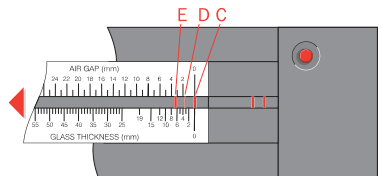

DIAGRAM 7

### Example 3, triple glazed

Place the Merlin Lazer flat against glass surface, butting up against the unit frame. Press the red button and hold it down, viewing the calibrated scale from approx 45 degrees. Six bright red laser lines will be visible. Check that the first laser line (A) is aligned with the zero line on the scale. The second laser line (B) shows the thickness of the first pane of glass - in Diagram 8 this is shown on the Glass Thickness scale as 4mm.

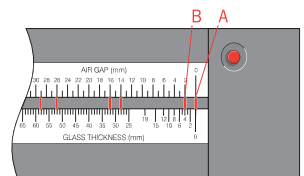

DIAGRAM 8

Slide the scale's zero line to align with laser line (B). Measure the air gap on the Air Gap scale, shown in Diagram 9 as 12mm by laser line (C).

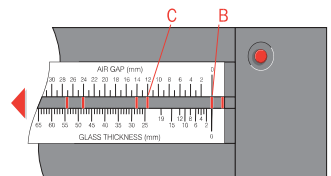

DIAGRAM 9

Slide the scale's zero line to align with laser line (C). Measure the thickness of the centre pane of glass on the Glass Thickness scale. This is shown in Diagram 10 to be 4mm by laser line (D).

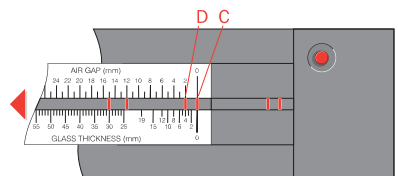

DIAGRAM 10

Slide the scale's zero line to align with laser line (D). Measure the second air gap on the Air Gap scale, shown in Diagram 11 as 10mm by laser line (E).

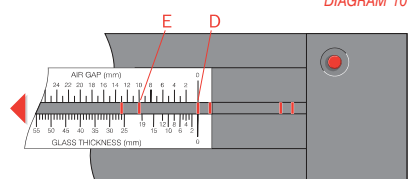

DIAGRAM 11

Slide the scale's zero line to align with laser line (E). Measure the thickness of the third pane of glass on the Glass Thickness scale. This is shown in Diagram 12 to be 6mm by laser line (F).

**This shows the unit's construction to be: 4mm glass; 12mm air gap; 4mm glass; 10mm air gap; 6mm glass. The unit therefore has an overall thickness of 36mm.**

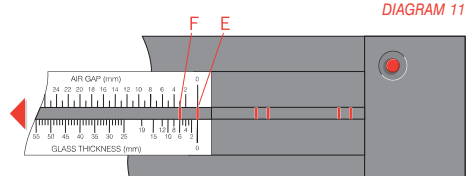

DIAGRAM 12

## Measuring air gap variance

Measure the air gap at the frame edge as described in Example 2. With the laser on/off button still pressed on, slide the Merlin Laser to the centre of the glass unit. If there is any deviation in the air gap across the unit, the variance will be instantly visible and measurable on the Air Gap scale.

## Care and maintenance of the Merlin Laser

The Merlin Laser requires minimal maintenance, there are no user serviceable parts.

To change the batteries unscrew the cover plate, remove the old batteries and replace with three standard silver oxide batteries - RW42, 357 or SR44W.

The sliding scale may need cleaning occasionally and this is best done with a soft, damp - **not wet** - cloth. Do not use petroleum or solvent based cleaners.

Do not attempt to remove or adjust the laser circuitry.

Do not expose the unit to extremes of temperature or humidity.

Do not severely jolt the unit.

Do not expose to any type of magnet.

If the unit is not in use for more than three months remove the batteries.

Never shine laser into eyes.

Keep away from children.

## Warranty and repair

In the event of defect in materials or workmanship, Merlin Lazer Products will repair or replace this product free of charge for a period of 12 months from the date of purchase. Proof of date of original purchase is required. In such an event return the product to: Merlin Lazer Products, Weald House, High Broom Lane, Crowborough, East Sussex TN6 3SP. The warranty does not cover deterioration or damage due to misuse. The warranty is extended only to the original purchaser. Please enclose a description of the problem. We recommend you insure the return package as we cannot accept responsibility for items lost or damaged in transit.

**LIMITATIONS AND EXCLUSIONS** Merlin Lazer Products shall not be responsible for incidental or consequential damages resulting from the use or misuse of this product, or arising out of any breach of warranty. The liability of Merlin Lazer Products is limited solely to the repair or replacement of the product. This product conforms to CENELC EN 60825-1 (1994) European Laser Safety Standards.

Manufactured by:  
Merlin Lazer Ltd - Weald House  
High Broom Lane - Crowborough  
TN6 3SP - U.K.  
tel: +44 (0)1892 654141  
www.merlinlazer.com

Caution - use of controls or  
adjustments or performance of  
procedures other than those specified  
herein may result in hazardous  
radiation exposure

Complies with 21 CFR 1040.10 with  
deviations pursuant to Laser Notice  
no.50, dated July 2001.  
Manufactured in the U.K.

