

# Everything Under Control with our CNC Software.

**HOMAG**

## **Software from the HOMAG**

CNC machines | woodWOP  
Simulation | Optimization

**YOUR SOLUTION**







## Integrated software

## Intuitive operation

## Individual modules

Choose from a wide range of software modules to find the optimum configuration for your requirements. A demo version can be found on our website: [www.homag.com](http://www.homag.com)

### YOUR SOLUTION

#### MORE: HOMAG.COM

---



Software

---

### CONTENT

- 04 woodWOP
- 06 woodWOP CAD-Plugin
- 08 woodWOP CAM-Plugin basic
- 10 woodWOP CAM-Plugin professional
- 14 Simulation and time calculation
- 16 Nesting software
- 18 woodCAD|CAM
- 19 woodAssembler
- 20 woodWOP DXF-Import
- 21 woodWindows window software
- 22 powerTouch
- 26 Software, Support and Service
- 27 Licence protection

# woodWOP

## The CNC programming system of the HOMAG

woodWOP is the CNC programming system of the HOMAG. The large graphics area with a three-dimensional view of the workpiece is the centerpiece of the innovative surface. Routing, drilling or sawing can quickly and easily be programmed by entering the machining parameters and displayed realistically in the graphics area. This guarantees

highest programming safety and permanent control during program generation.

Worldwide largest forum for woodWOP:

**forum.homag.com**

Free download of woodWOP components:

**www.homag.com**



**Basic functions:** A large selection of standard processing operations such as drilling, sawing grooves or pocket milling offer an ideal basis for fast, reliable programming.

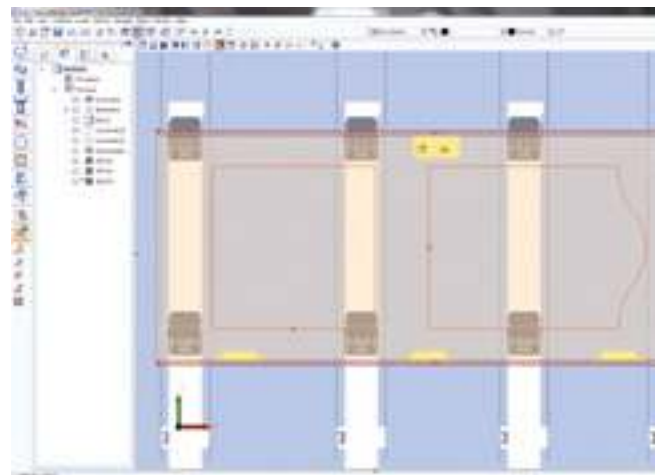

**Components:** Customers can use components to program their own processing operations and save them in woodWOP. These are integrated into an existing program at the click of a mouse. On our website there are several components available for free download.



**File preview and thumbnail view:** In the Windows file explorer, MPR(X) files can be displayed as thumbnails. The contents of the files are recognizable at a glance. With the file preview, a large graphic as well as the contents of the comment macro are displayed in the Windows Explorer.

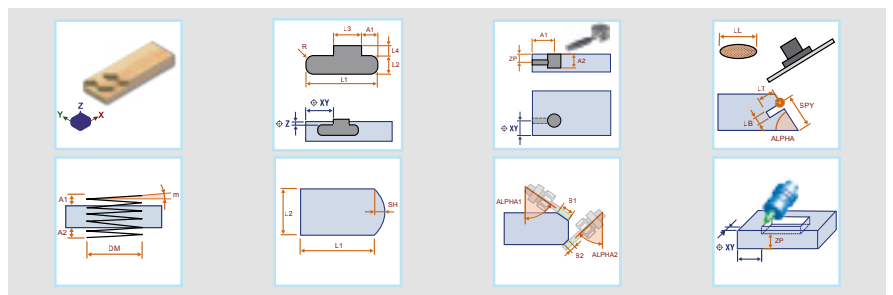

**Examples from the component library**

### BENEFITS

- Higher programming accuracy due to 3D graphics of workpieces, machining and clamping aids.
- Very easy to operate due to the new design of the user interface, e. g. individually adjustable windows, multiscreen ability, language-neutral input masks, help images etc.

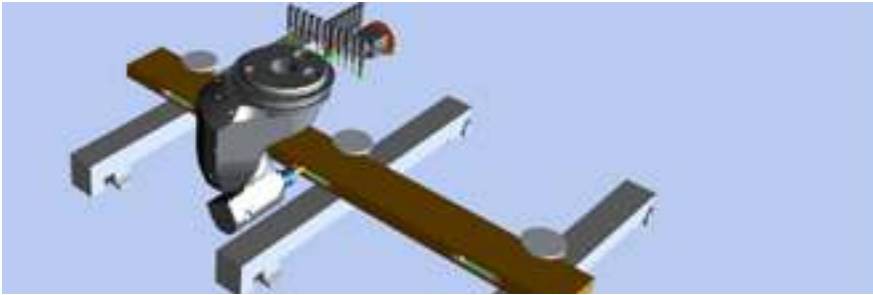

**Tool optimization of components:** From woodWOP 7.1, components can be grouped in a block and optimized for minimal tool changes.

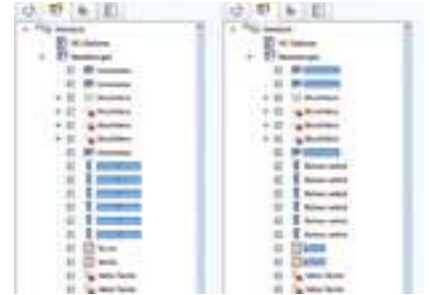

**Multiple selection:** Selection of macros for deleting, copying, duplicating, and moving

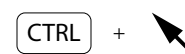

= Multiple selection of individual objects

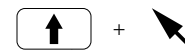

= Multiple selection of sequential objects

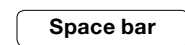

Press the space bar to activate or deactivate



**Positioning axis programming:** The fifth axis can be simply programmed in woodWOP as a positioning axis. Tool preview and processing path preview simplify the programming process and lend assurance to the programmer.

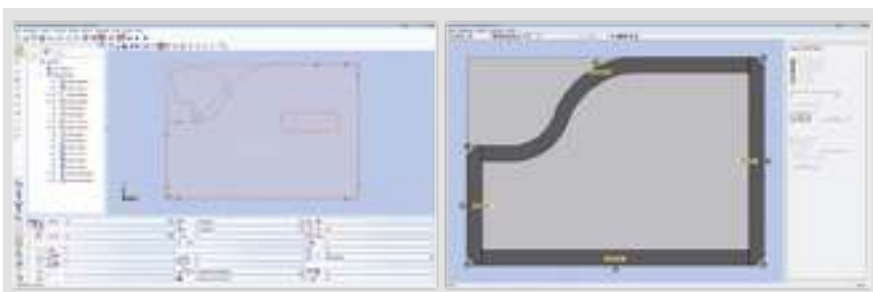

**woodWOP Wizard:** The woodWOP Wizard allows all processing operations for edge banding to be automatically generated at the press of a button. An edging suggestion is generated on the basis of the specific contour. This can be subsequently edited and adapted. The result is displayed directly in woodWOP.

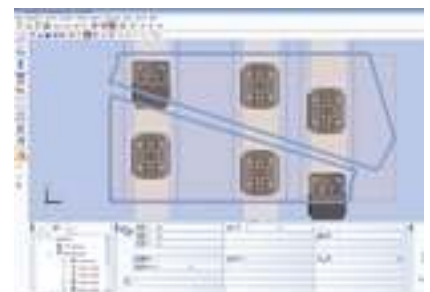

**Suction cup suggestion:** The integrated suction cup suggestion feature automatically calculates the position of clamps depending on the programmed processing operation.

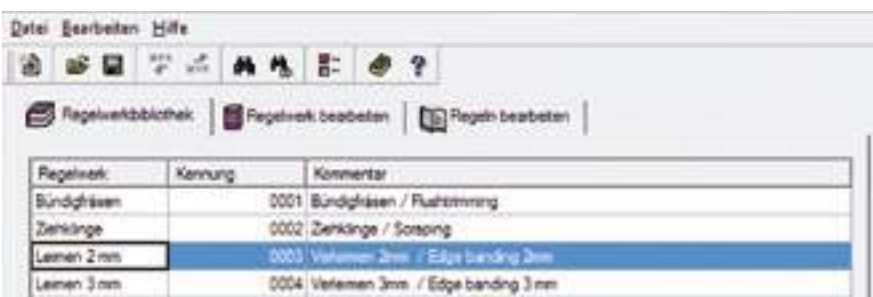

**Technology database:** Process parameters are automatically changed and the woodWOP program adjusted depending on the workpiece contour. E.g. 2 mm PVC edge: If the radius is smaller than 30 mm, then reduce feed and switch on heating nozzle.

# woodWOP CAD-Plugin

## Integrated 2D-CAD functions for woodWOP

Using the CAD plugin, contours can be quickly and conveniently created. Interactive lines, arcs, circles, ellipses and splines can be drawn. A wide selection of editing

functions such as trimming, extension or mirroring are available. A contour tracking function converts all generated drawing elements into a continuous contour line.

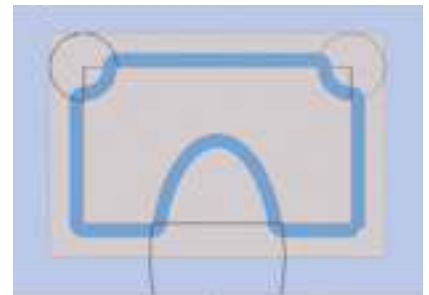
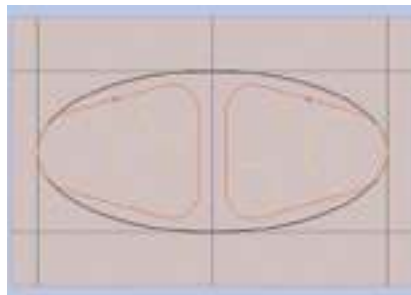
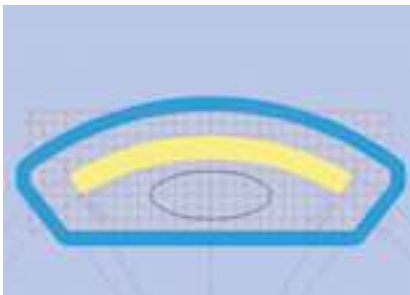

### Drawing

- Lines, arcs, circles
- Ellipses, elliptical arcs
- Splines
- Rectangles, n-cornered

### Bearbeiten

- Displacement, rotation, mirroring
- Scaling
- Multiple copying and displacement/rotation
- Trimming, extension, splitting, rounding, chamfering
- Displacement

**Contour line generation:** By selecting a starting point and specifying a direction, individual CAD elements are automatically connected to create a cohesive woodWOP contour line. At intersection points, the operator decides further progress by interactively selecting the elements in the graphic.

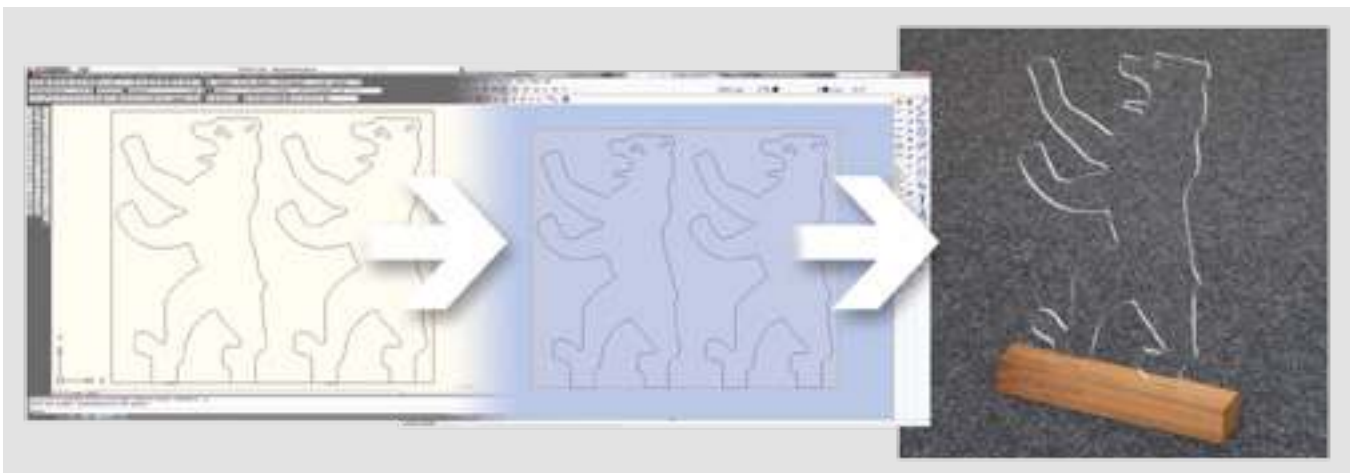

**DXF-Import:** Already existing CAD drawings in DXF format can be read in and processed directly. A special layer allocation function is not required.

## 3D-CAD construction directly in woodWOP

The design possibilities are extended by 3D-CAD functions.  
The operator has got the opportunity to create 3D areas in

a simple way or to open completed 3D-models directly in woodWOP.



**Design possibilities:** Construction of surfaces by cross-sections, guiding lines, limits, rotation, extrusion, etc.

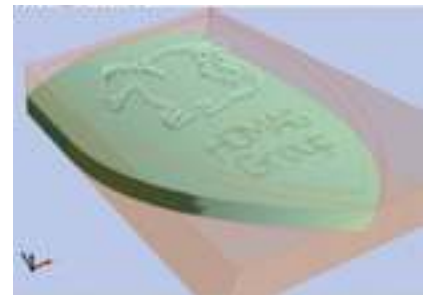

**Projection:** Projection of geometry elements and lettering on 3D surfaces



**Import of 3D models:** Import of 3D-CAD drawings as \*.igs, \*.stp \*.dxf (3D) or, \*.stl file format

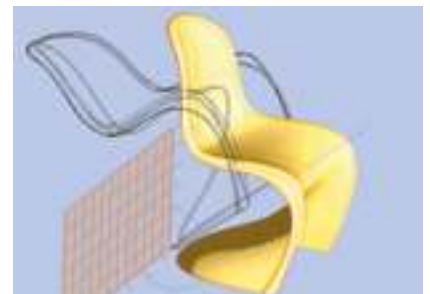

**Editing of 3D objects**

- 3D-rotating, 3D-mirroring, 3D-scaling
- Trimming, extending, rounding

### BENEFITS

- CAD functions integrated directly into the woodWOP interface
- Intuitive operation and fast familiarization with an identical look & feel
- Support in the design of step-by-step instructions

# woodWOP CAM-Plugin basic

## Processing of 3D-surfaces with woodWOP

With the woodWOP CAM-Plugin the HOMAG heralds a new age in machine-oriented programming. When in former times the router was programmed via contour elements, the CAM-Plugin actually allows to select a surface according to which

the software then automatically calculates the required paths. The CAM-Plugin completes the function range and enlarges woodWOP to a fully-fledged CAD/CAM-system within 3D-surfaces can be processed in a 3-axis way.

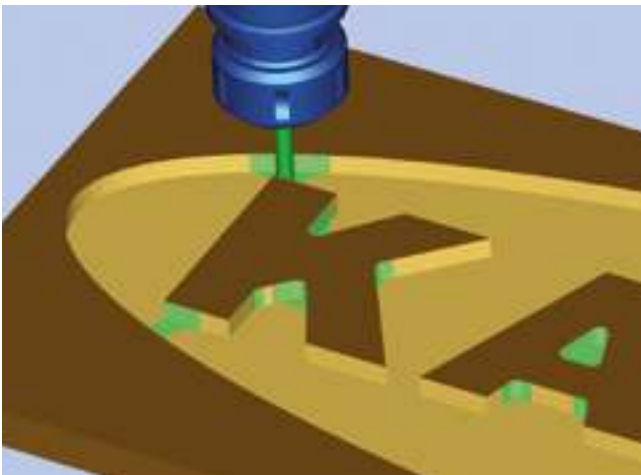

### Pocket trimming with islands

- Removing material inside a pocket
- Remaining material of internal elements („islands“)
- Residual material recognition, i.e. with the second tool only the material which the first tool was unable to remove is finish trimmed

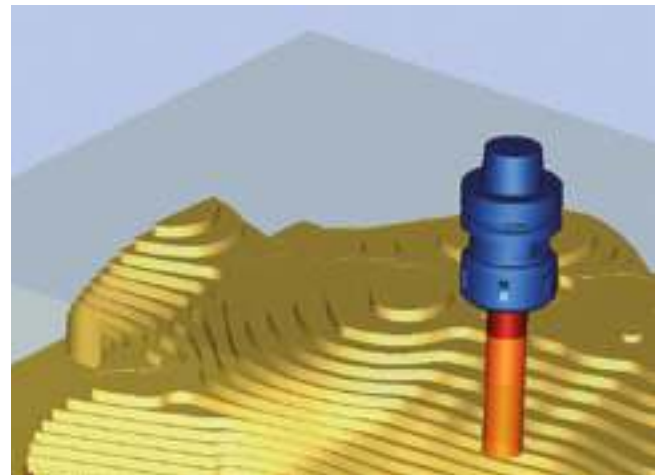

### 3D-roughing

- Preliminary processing of the workpiece for subsequent fine processing
- As much material as possible is removed in as short a time as possible
- The tool paths are calculated automatically once the surfaces have been selected

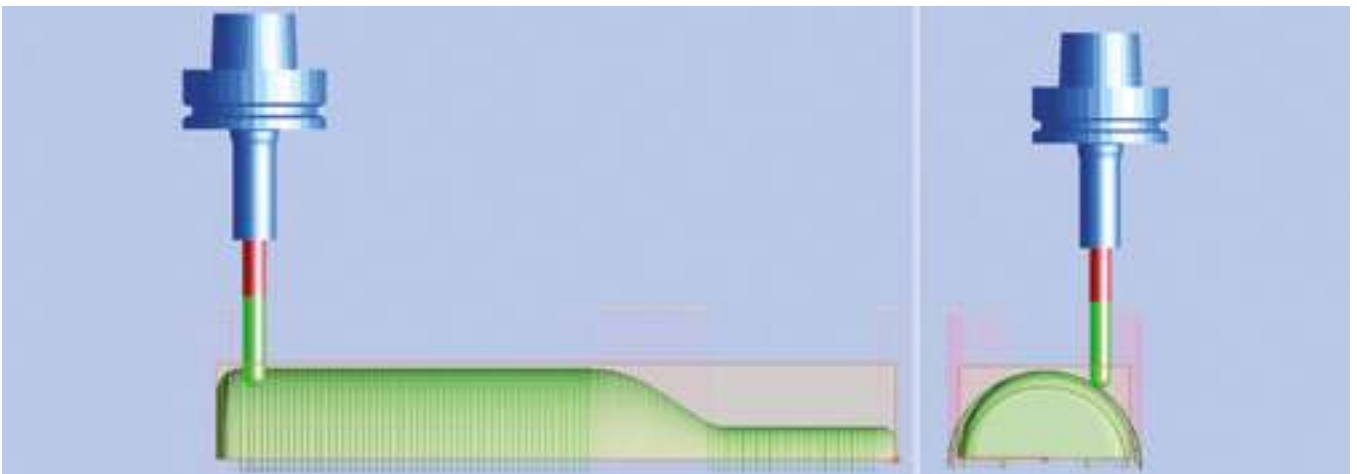

### 3-axis processing of a 3D-object



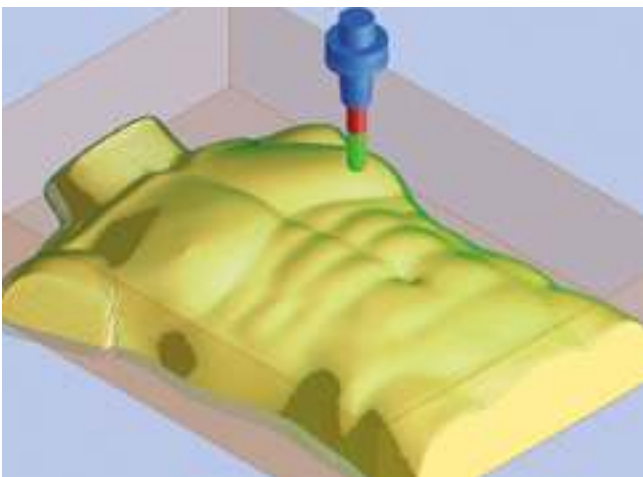

**3D-finishing**

- Fine processing of the surfaces
- 3D surfaces are created by tracing with a spherical cutter
- Different routing strategies for vertical 3-axis routing

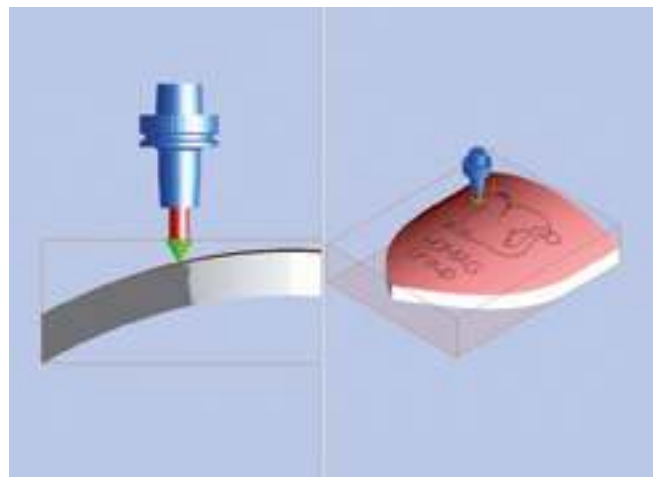

**3D-curve trimming**

- Trimming 3D lines
- Engraving and text on curved surfaces
- Vertical orientation of the cutter (3 axis engraving)

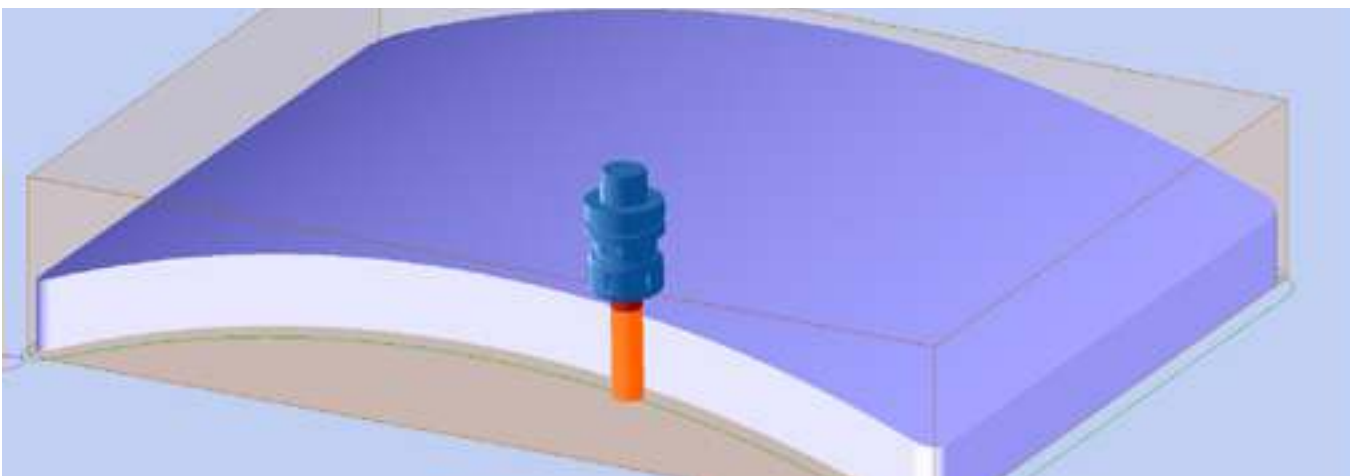

**3D peripheral trimming**

- Tool orientation with two guiding lines or using a surface
- Selection of different strategies for corner processing for perpendicular orientation of the tool

# woodWOP CAM-Plugin professional

## Processing of 3D-surfaces with woodWOP

The CAM-Plugin completes the function range and enlarges woodWOP to a fully-fledged CAD/CAM-system within

3D-surfaces can be processed in a 3-, 4- and interpolating 5-axis way.

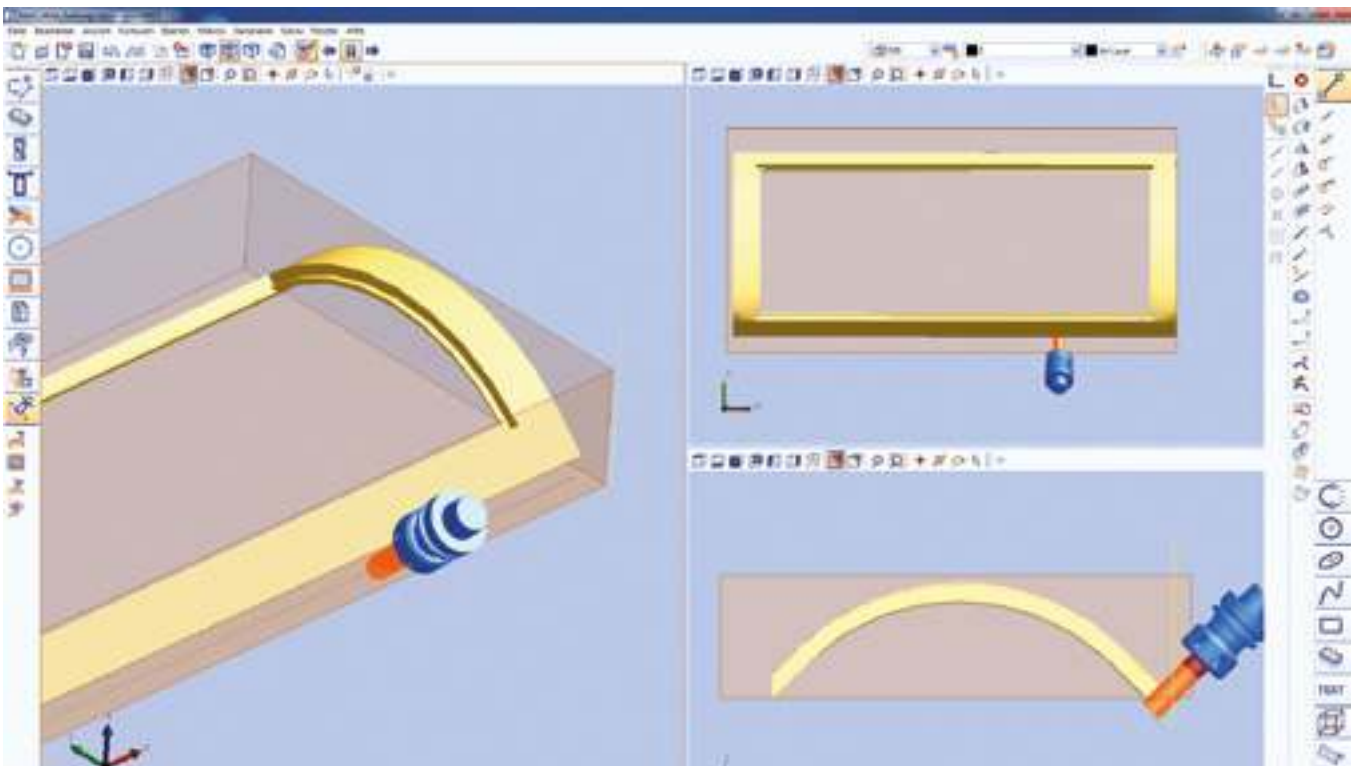

**Interpolating 5-axis machining of a free-form surface**

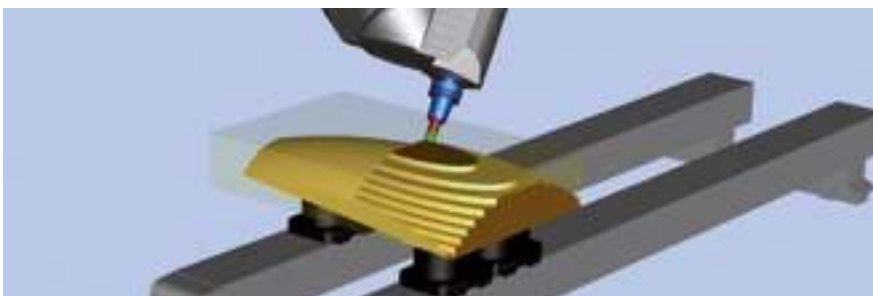

### **3D-roughing and finishing**

- Programming by selection of the surface that should be processed
- Automatic calculation of tool paths
- Different routing strategies (3-, 4-, 5-axis)
- Different approach and retract modes

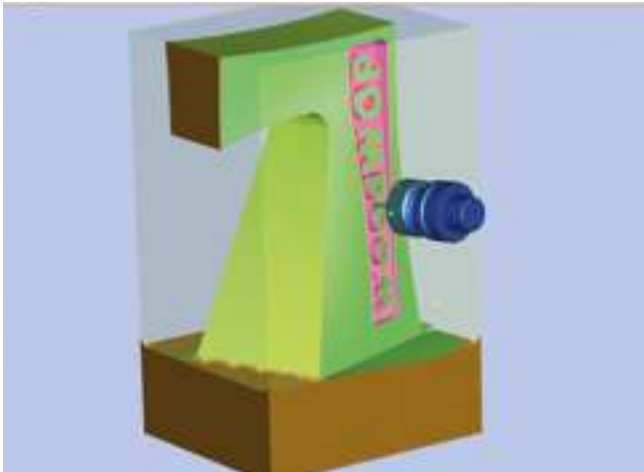

### Pocket trimming with islands

- Removing material inside pockets on any working levels
- Remaining material of internal elements („islands“)
- Residual material recognition: with the second tool only the material is milled which could not be re-removed from the first tool

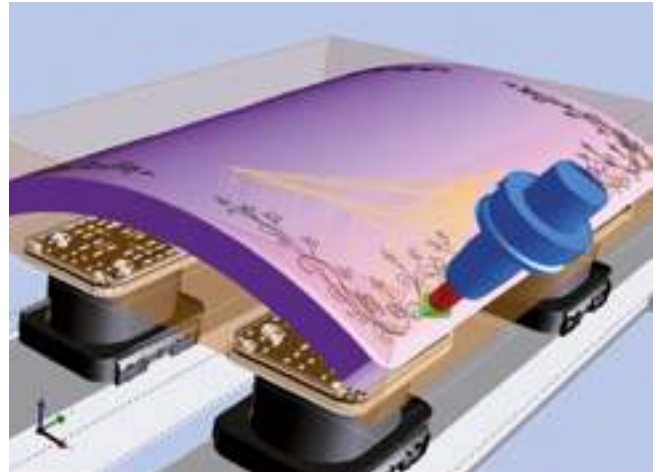

### 3D-curve trimming

- Trimming of 3D lines
- Engraving of text objects and geometries on curved surfaces
- Automatic orientation of the tool perpendicular to the surface

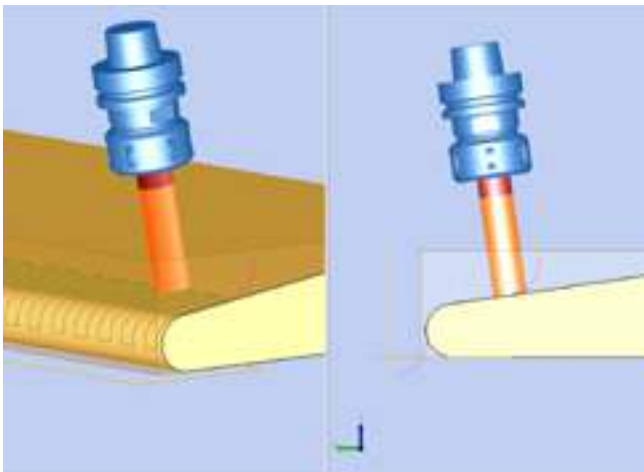

### 3D-finishing

- Various trimming strategies and adjustable processing parameters
- Detailed definition of travel ranges through boundary angles
- Realistic representation of the tool track directly in woodWOP

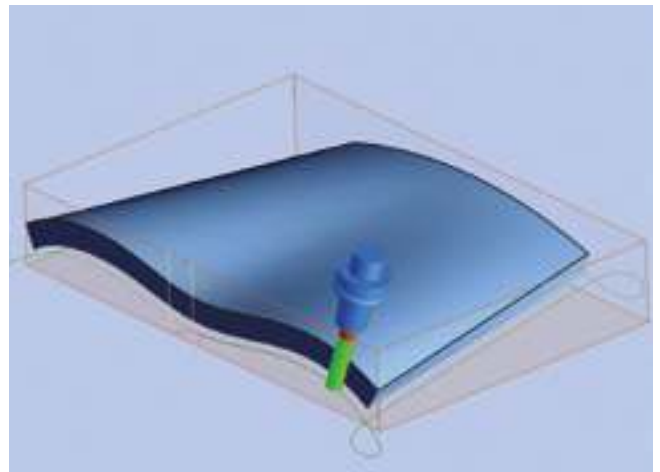

### 3D peripheral trimming

- Tool orientation with two guiding lines or using a surface
- Selection of different strategies for corner processing in any orientation

# woodWOP CAM-Plugin professional

## Processing of 3D-surfaces with woodWOP

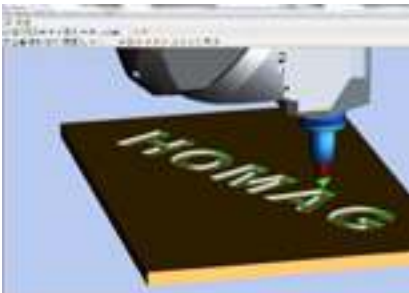
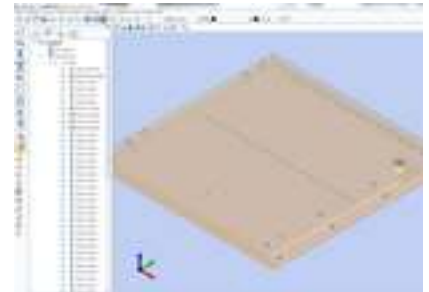
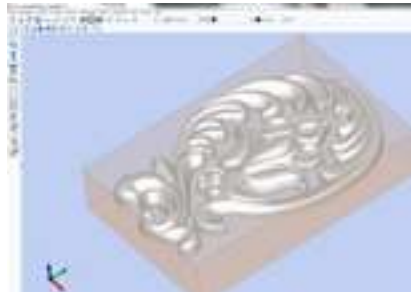
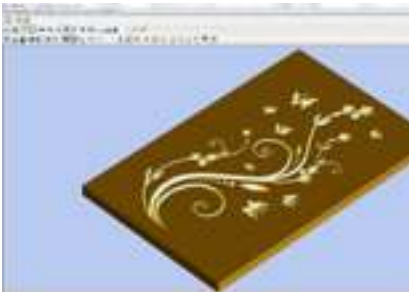
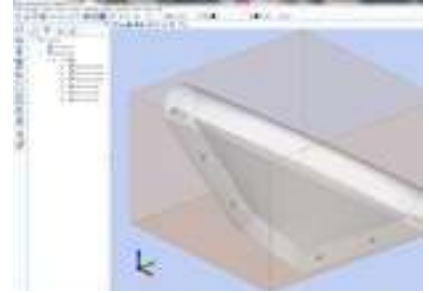
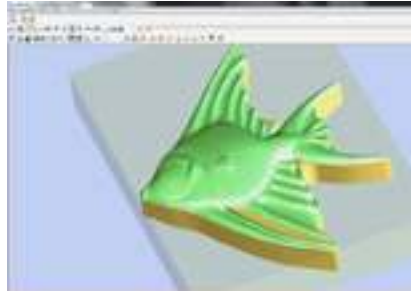

### 3D-Engraving

- Engraving of closed, coplanar (=in one plane) contour definitions
- The macro recognizes the inner side of closed curves and sets the tool path on this side
- Tool is automatically raised in the corners
- Tool: Stylus trimmer

### STL 3D-surfaces trimming

- The tool orientation can be defined in the macro and remains fixed during processing (adjustment axis)
- Different trimming strategies and limits allow easy programming of complex surfaces
- Typical use cases are the trimming of digitalized objects, 3D reliefs, and ornaments

### Feature detection drilling

- Automatic detection of „holes“ in a 3D model
- Automatic creation of woodWOP macros
- Depending on the orientation of the cylinder coating surfaces, vertical, horizontal, or universal bore holes are created
- Using further sets of rules, woodWOP components can also be added automatically

## Surface-based sawing

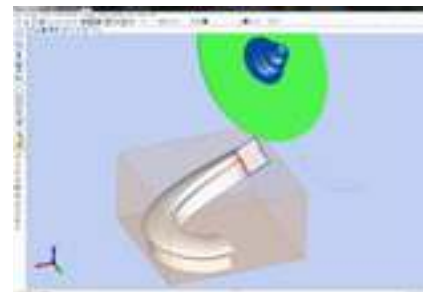
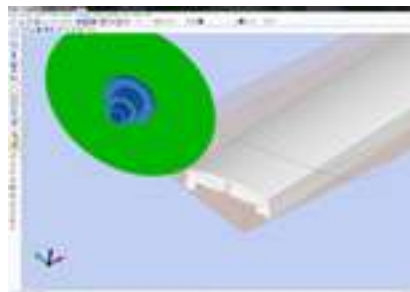
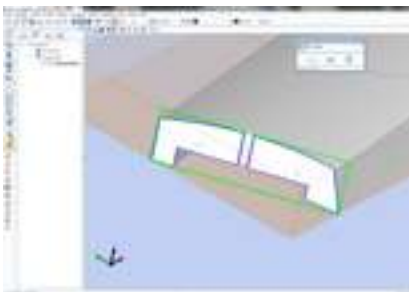
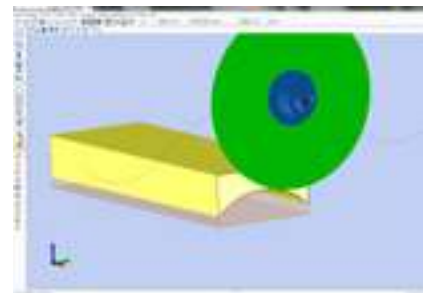
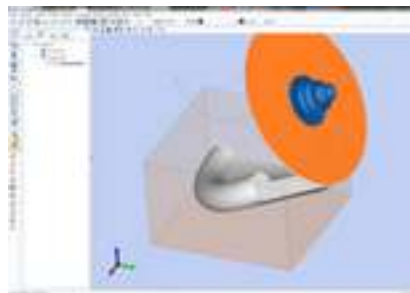
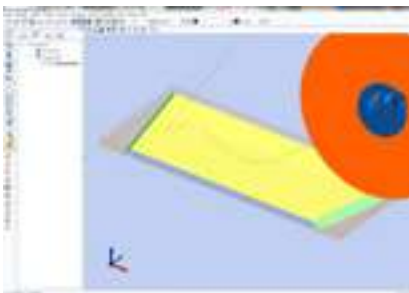
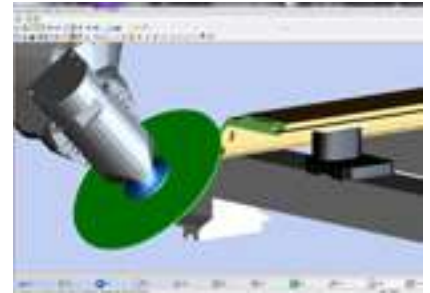
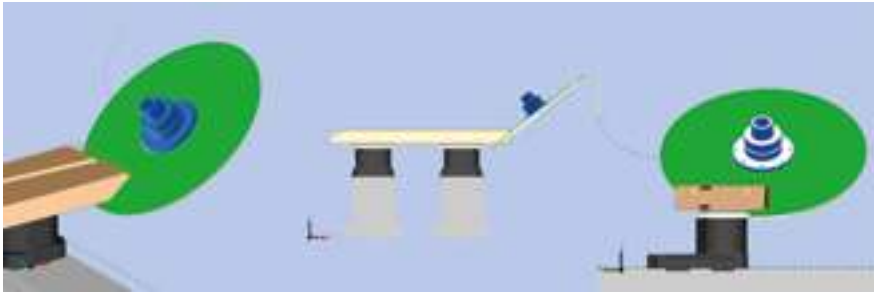

### Mode: Automatic

- Selection of one or more coplanar surfaces
- Automatic creation of the smallest possible rectangular surface for non-rectangular basic surfaces
- Automatic generation of saw cuts incl. approach and withdrawal cycles

### Mode: Manual

- Selection of one or more coplanar surfaces
- Selection of a guide curve from the 3D model or selection of a line of the surrounding rectangle

## BENEFITS

- CAD/CAM system fully integrated in woodWOP
- Processing of CAD data in the usual exchange formats for the market: STEP, IGS, 3D-DXF, and STL
- Generation of the milling paths of the three-axis to the interpolating five-axis processing for roughing down, finishing, and formatting of 3D objects
- Automatic sawing on surfaces and automatic detection of bore holes in the 3D model

# Simulation and time calculation

## Software for the simulation of CNC programs

The programs for simulation and time calculation enable machining processes to be simulated, calculated and

checked for errors already in the office.

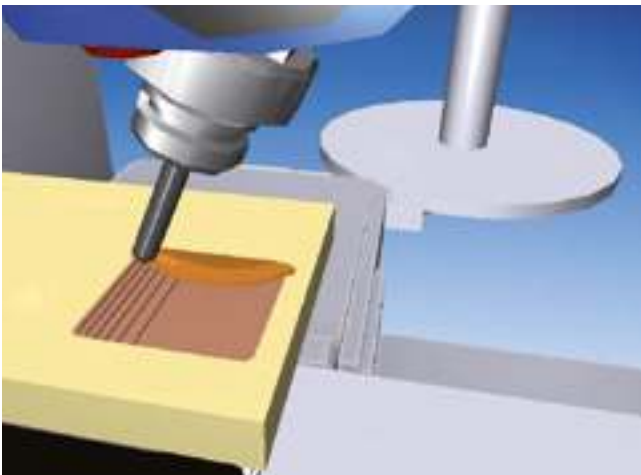

Simulation including stock removal

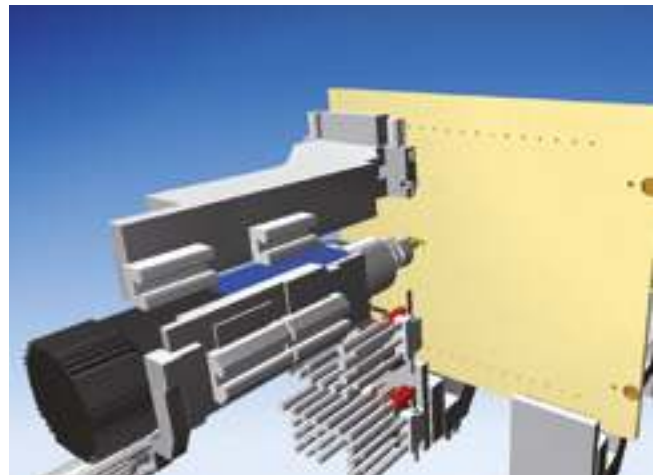

Vertical processing on a DRILLTEQ

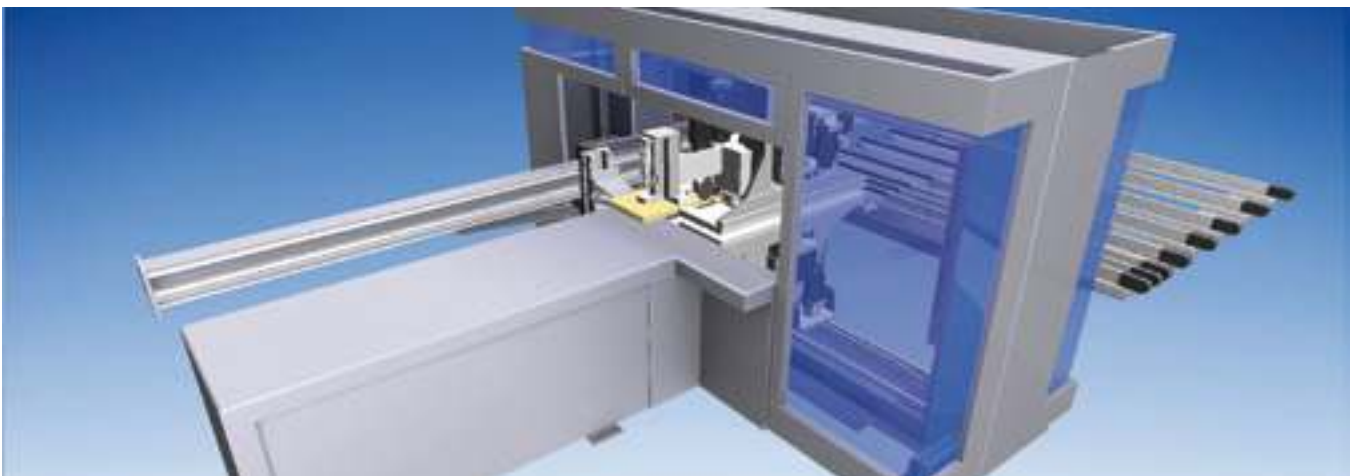

Realistic depiction of the machine and tools

**3D CNC-SIMULATOR | SERIES:**  
**DRILLTEQ H-200|600, DRILLTEQ V-200|600,**  
**CENTATEQ P-110|200, CENTATEQ N-300|800.** An automatic routine determines the machine configuration and

tools fitted. The positions of suction cups and modules in the NC program are displayed and checked for collisions in the case of machining steps completely through the board.

**WOODMOTION | SERIES: CENTATEQ E-310, CENTATEQ P-310, CENTATEQ E-500|600, CENTATEQ P-500|600.** woodMotion uses the office PC to simulate work steps at the machine, and provides a graphic representation of processing operations at the workpiece.

This affords the programmer the opportunity to check the processing steps in advance and detect any potential collisions between tools and clamps. The simulation is based on a virtual machine with a real CNC core actuated by means of the data of the respective customer machine.



Simulation on the machine PC

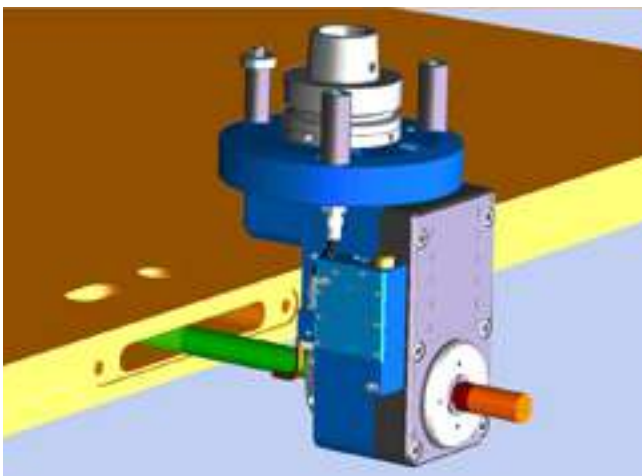

Display of units

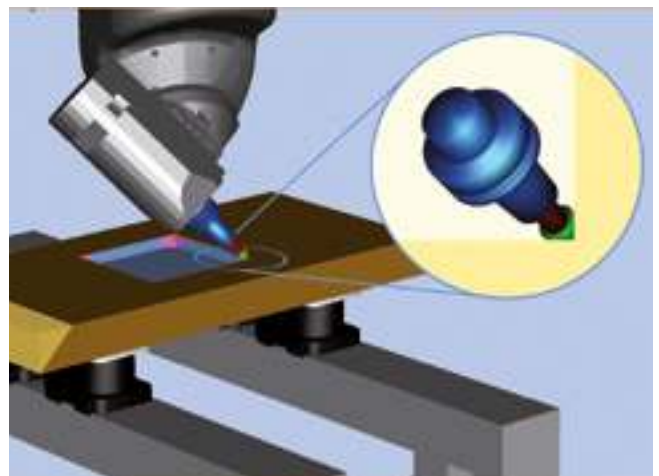

Cutting out corners with a five-axis head

## BENEFITS

- Reduction of machine running-in time due to optimum program preparation
- Simulation of 5-axis processing including material removal
- Collision control between tool and clamps

# Nesting software

## Solutions for nesting of components

Nesting technology means to „nest“ workpieces in order to achieve optimum material utilization by using cutting optimization. Nesting offers the opportunity to economize

significantly on materials particularly when processing a large variety of shaped parts.

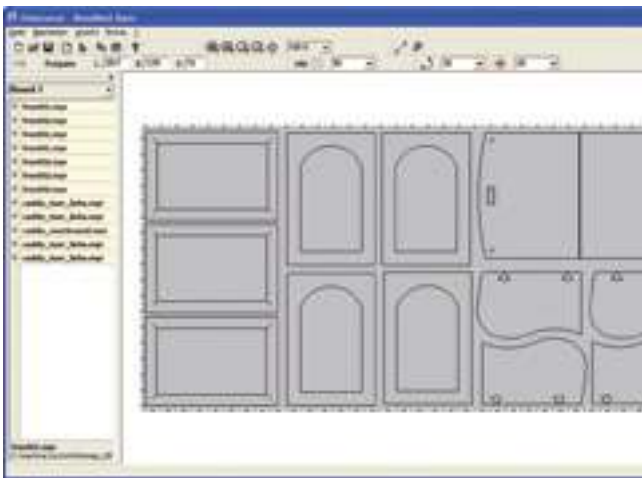

### woodNest Basic

- Software for manual nesting of shaped parts
- woodNest Basic is an easy solution for users who occasionally want to program nests
- woodWOP programs can be manually nested, positioned and rotated with a mouse



- Cut Rite Nesting:** Cut Rite, the optimization software of the HOMAG Group, is used for cutting boards on sawing machines as well as nesting machines. The modular structure of the software allows users already controlling their sawing machine via Cut Rite to integrate the nesting module without problems.
- Board library and calculation of material costs
  - Labeling in the office incl. layout editor
  - Additional modules can be applied optionally, e. g. for stock management





**Management summary**

HEL-CM1-15AM

Description	Quantity	Vol	Percent	Base	Cost	Material	Value
Required parts	41	10.00	17.87%			Number of tables	4
Plus-Over parts	0	0.00	0.00%			Number of patterns	4
Offcuts	1	1.13	19.25%			Number of cycles	4
Scrap	3.07	10.91%				Cutting length	1.4
Loss area	0.00	0.00%				Management Agency	0.0
Board	4	14.56	100.00%			Material (Plywood)	43.87%
						Waste (filling)	52.93%
Board used	14.56	100.00%	1.198	20.15			
Offcuts used	0.00	0.00%		0.10			
Offcuts saved	-0.72	-19.25%	-0.889	-0.10			
Material saved	-17.16	-81.25%	-1.988	-36.10			
Cutting time	0.00%			1.000	1.10		
Total parts	41	14.56	100.00%	3.027	38.15		

**Cut Rite Nesting - Result:** Cut Rite provides a clear and structured presentation of the results of the optimization. For every optimization run several reports are issued, which can be individually configured.



**Cut Rite Nesting - Parts list**

- Can be manually created by entering individual woodWOPfiles
- Can be imported from other programmes, e.g. excel charts
- Can be optionally edited and processed
- Import of up to 50 woodWOP-variables
- The programme optimises the parts list sorted according to material or any other parameter

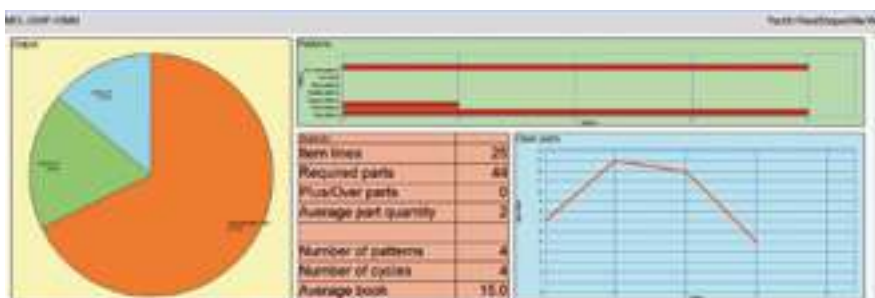

**Cut Rite Nesting - Result**



**Cut Rite Nesting - Label designer**

- With the integrated label designer you can create labels at your workplace and print them directly in the office
- This function does not replace the automatic printing function at the machine

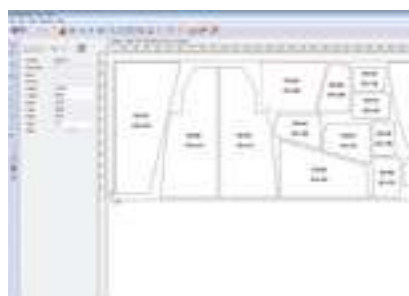

**Cut Rite Nesting - Editor:** As needed, the optimization result can be manually modified, e.g. adding filling parts.



**Cut Rite Nesting - Cutting plan templates:** It is possible to create cutting plan templates, e.g. for furniture fronts, in order to guarantee a continuous texture over several individual parts.

**BENEFITS**

- By combining cutting and final processing intermediate stacking of individual items is not necessary
- Material costs can be reduced and the overall processing time can be cut

# woodCAD|CAM

## Integrated software for 3D design and production of furniture and for interior fittings

From the concept to the end product: As an integrated software solution, woodCAD|CAM supports the entire process, from planning and presentation to the design and production of the planned items of furniture. Regardless of

whether you're producing individual pieces or planning entire room concepts — with woodCAD|CAM you save time, avoid errors, and work efficiently.



**EASY. EFFICIENT. IMPRESSIVE.** Designs for individual items of furniture or entire room planning can be created in a very short time and presented impressively with photo-realistic images. You want to change something? No problem! You can change details or entire assemblies easily at any time and then cost and present them.

**INDIVIDUAL. OPTIMAL. AUTOMATED.** After the design phase, the production documents and CNC programs can be generated at the push of a button. The cutting list is transferred directly to the Cut Rite cutting optimization. The barcodes created by woodCAD|CAM allow you to organize your order and production processes so that they are reliable and free from errors.

### BENEFITS

- Integrated data flow from the concept to the finished item of furniture
- A time saving of up to 70% in the work preparation
- Automatic creation of sales documents: photo-realistic presentation, quoting, and drawing proposals
- Free, parameterized 3D design
- Extensive fixtures libraries

# woodAssembler

## Virtual assembly of workpieces in woodWOP.

woodAssembler displays your projects in 3D and makes it possible to assemble components using the mouse. Your programs generated in woodWOP are used as the data source. Modern technology makes it possible for you to check the components virtually and in this way find errors conveniently on the PC without the need to manufacture

expensive prototype woodAssembler also imports complete objects including all hardware from the Dynalog program of hardware manufacturer Blum, and generates a woodWOP program for every component. Access is also afforded to all the connectors and hardware contained in the Hettich catalog.

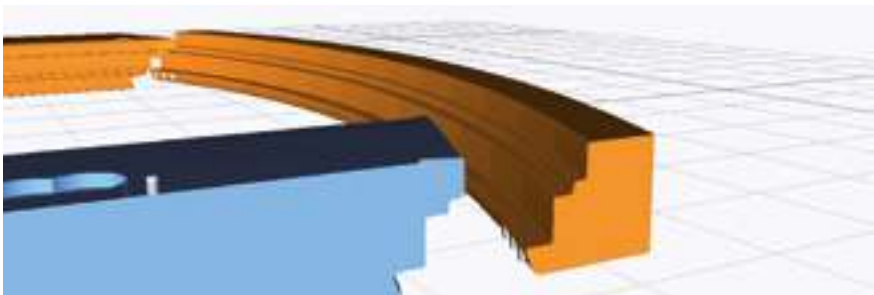
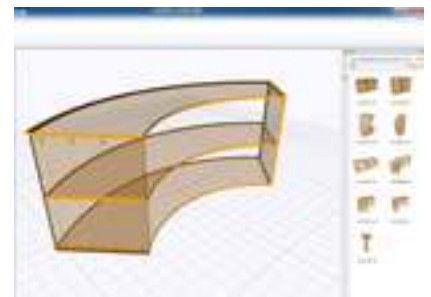

### WOODASSEMBLER: DEPICTION OF TOOL PROFILES

Variable programming

- **Variables in woodWOP programs can be defined as global variables for a particular object. Changing these variables affects the whole of the object.**

Depiction of tool profiles

- **Existing tool profiles exert an effect on the workpieces in woodAssembler. This allows convenient control of programmed Z coordinates**

### BENEFITS

- **Realistic representation of objects, including fixtures**
- **Direct control over programmed components**
- **Cost and time savings due to elimination of the need to produce prototypes**
- **Particularly effective during series production or when working with high-quality materials**

# woodWOP DXF-Import

## From the drawing straight into production

The widely used, independent DXF format for the exchange of CAD drawings is used as the basis for the generation of woodWOP programs. Workpieces having been drawn

once can be imported into woodWOP and transferred to the machine straight away.



**Preparation of the DXF file:** The individual layers (levels) of the drawing contain all the relevant information for the machining operations.



**Conversion:** With the aid of a preset rules, all drawing elements from the DXF files can be converted into processing operations.

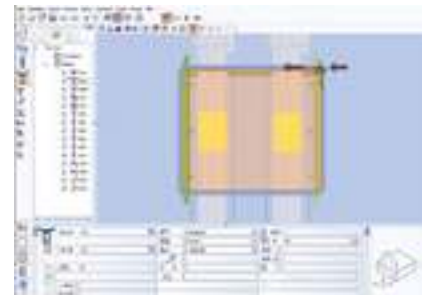

**Output in woodWOP:** When the data is transferred, the processing operations are then automatically generated.

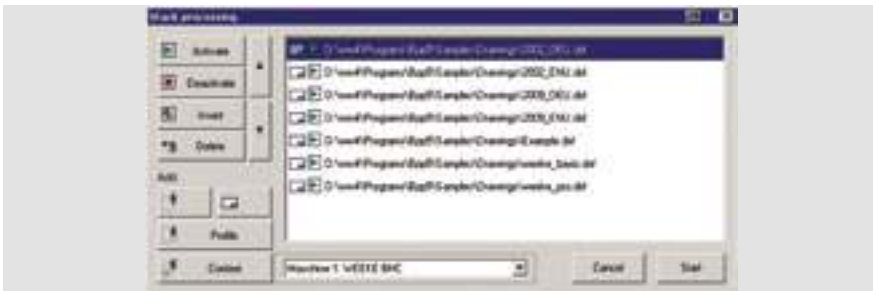

**DXF Import Professional including stack processingg:** Special applications can be extended. The conversion rules can be flexibly expanded as required for each machining type. As a result, almost all possibilities can be covered by woodWOP. The stack processing feature allows any optional number of DXF files to be converted into woodWOP programs with a start process.

## BENEFITS

- Workpiece has to be programmed only once
- Straight from the drawing to the machine
- No reworking in woodWOP necessary

# woodWindows window software

## The fast start-up into the CNC window manufacturing

From the predefined entry-level package „Advanced“ via the expandable modules to „Professional“ – the projecting of a complex manufacturing environment – woodWindows

offers a tailored-made concept for every requirement at an optimum price-performance ratio.



### Advanced

- Starter package inclusively master data for CE-certificated profile systems „climatrend“ (turnkey)
- Module of leading German industry software suppliers
- Functional modules expandable (such as invoicing)
- Machine-oriented

### Professional

- Individual project attendance by HOMAG window and software specialists
- Project-related integration of the systems
- Integration with already existing or new industry solutions
- Individual start-up at HOMAG and on-site
- Individual KnowHow transfer
- Turnkey handover after the defined scope of service
- Individual machine optimization
- Individual scope of service

## BENEFITS

- Safety right from the start through frequently applied system
- Minimal start-up time „Plug and Play“ by predefined master data
- Fast training through simple processes
- Smooth handling through turnkey handover with defined interfaces

# powerTouch

## Many different technologies – one user interface!

powerTouch implements the HOMAG's new operating philosophy: Easy, equal, ergonomic and evolutionary. The innovative touchscreen operating concept unites design and function to create a totally new control generation. At the focus of this solution is a large multi-touch monitor

in widescreen format, which is used to control machine functions by direct touch contact. The entire user interface has been optimized for touch operation and offers an array of help and assistance functions designed to radically simplify the work experience.



### Easy – Operating convenience included

- Fast overview of machine status
- Traffic light assistant helps guide the user towards readiness for production.
- Self-explanatory symbol texts and integrated help mode

### Equal – All machines, a single control system

- Standardized design of the user interface
- Same operation of basic functions for all HOMAG machines
- Standardized operating control center for all main machine functions



### Ergonomic – Hands-on technology

- Intuitive, natural touch operation of the machine
- Use of gestures such as zooming, swiping, scrolling
- New ergonomic design of the control center

### Evolutionary – Ahead of its time

- Design and function united to create a totally new control generation
- Futuristic operating philosophy based on a large multitouch monitor

# MMR – Machine Monitoring & Reporting

The optimum utilization of machines and plants is one of the key success factors in manufacturing processes. The economic potential lies in an increased output and the

respective added value or in the reduction of operation times and the associated variable cost of operation for human resources, energy, compressed air and dust extraction.



## MMR Basic

- Logging of automatically justifiable statuses using the machine control system
- Logging of shift changeovers
- Evaluation of key indicators and numerical depiction at the machine control system
- Display and logging of maintenance measures

## MMR Professional

- Graphic analyses in the form of Gantt, Pareto and line charts over optionally selectable time intervals
- Manual input of reasons for production disruptions
- Integrated downtime analysis with evaluation of corresponding error messages
- Link to MMR Office for central analysis in the office

## MMR Office Client

- Central evaluation in the office
- Clear evaluation of several machines in one PC

## BENEFITS

- Optimization of production by display of frequent error sources
- Increased production availability due to preventive maintenance measures
- More efficient machine deployment due to the transparent depiction of standard key indicators

# powerTouch



**Graphic tool database:** The graphic tool database editor permits the reliable, convenient input and modification of tool data. Dimensioned graphics are provided to assist the machine operator when setting up new tools and units.



**Tool service life determination:** The tool service life determination function is used to log and monitor tool sets. This data can be used to optimize tool deployment and for selection of the optimum tool.



**woodScout - Diagnostic system:** The diagnostic system woodScout provides a visual depiction of error messages and troubleshooting suggestions. The systematic location and remedy of faults are aided by helpful graphics.



**collisionControl | Series:**  
**CENTATEQ P-300|500|600,**  
**CENTATEQ E-300|500|600**

- Automatic stop of the machine in case of an imminent crash situation
- Display of the crash situation in the form of a snapshot with collision bodies shown up in colour
- Monitoring of 5-axis processing operations and manual traversing records in manual mode





**Barcode control**

- CNC programs can be loaded directly using a barcode. As a rule, the barcode corresponds to the name of the woodWOP program
- Simple scanning and clear assignment to the workpiece
- Reduction of input errors by the operator
- Transfer of stop positions and workpiece variables is possible



**woodBase extension**

- This is required if a workpiece has to be clamped several times (Example: Door processing on both sides) and only one barcode is available
- In a database, completion of the first clamping operation (processing operation) is logged
- When the same barcode is accessed again, a different program is loaded from the database

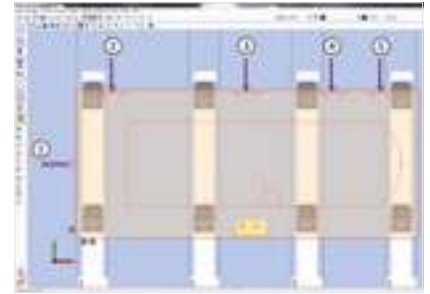

**Software multiple measurement for measurement probe**

- Up to 100 measurement points can be entered in sequence
- The following processing operations can refer to any optional measurement
- This optimizes the program sequence and the processing time is substantially reduced



**Visualization of main spindle vibration data**

- Detection of critical vibrations during processing
- Display of a warning and cut-off limit
- Permits monitoring of tool/balancing quality
- Tracing of chatter marks



**PC86 Production protocol**

- Acquisition of production key indicators (e.g. date, piece number, program start/end) and production events (e.g. interruption)
- Evaluation of information by MS Excel or external production control system

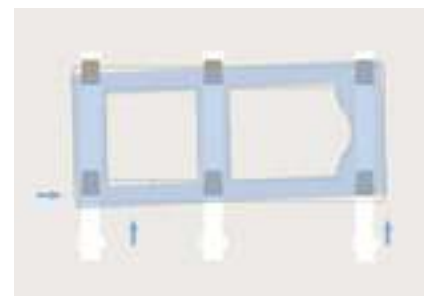

**Software position measurement for measurement probe**

- Software package for the measurement probe system for position detection of workpieces on the table
- Automatic rotation of the coordinate system in the CNC program using the determined measurement points
- Examples: Measurement after automatic feeding, automatic determination of raw part offsets, stops with coating ply overhang

## Software Support and Service

INTELLIGENT DIGITAL SOLUTIONS. We can help you with installation, updates, and licensing questions for all HOMAG software packages. Our software specialists have an extensive knowledge of programming solutions and industry packages to guarantee high productivity levels for your business. We can support you with the following tasks:

- **Installation and licensing of HOMAG software**
- **Program correction in woodWOP at the work preparation station**
- **Advice on programming tasks**
- **Software updates/upgrades**
- **Services for digitalization and programming of components**
- **Window and door programming**



**3D scanning and programming of a customer component**

# Licence protection

The HOMAG software is licence protected

**Single workplace licence:** In case of single licences every user gets one licence for his/her workplace. If a further workplace is to be established, a further licence must be purchased.

**Floating licence (network):** With floating licences the server manages the software licences for several users in one network.

For example, the software can be installed on six computers in the customer's network, while the licence only allows three simultaneous operators.

If, for example, a fourth user wants to log in, they receive a notification that there are no more licenses available. However, if one user exits the software, this licence is available again.



1 Client

2 Server

## **HOMAG Group AG**

info@homag.com

www.homag.com



## **YOUR SOLUTION**